

LOC	DIST	REV	DATE	BY	APPD
A1	-		23MAY2006	J.Z.	H.S.
		B1	12-JUL-07	EW	MS
		C1	18-JUL-07	EW	MS

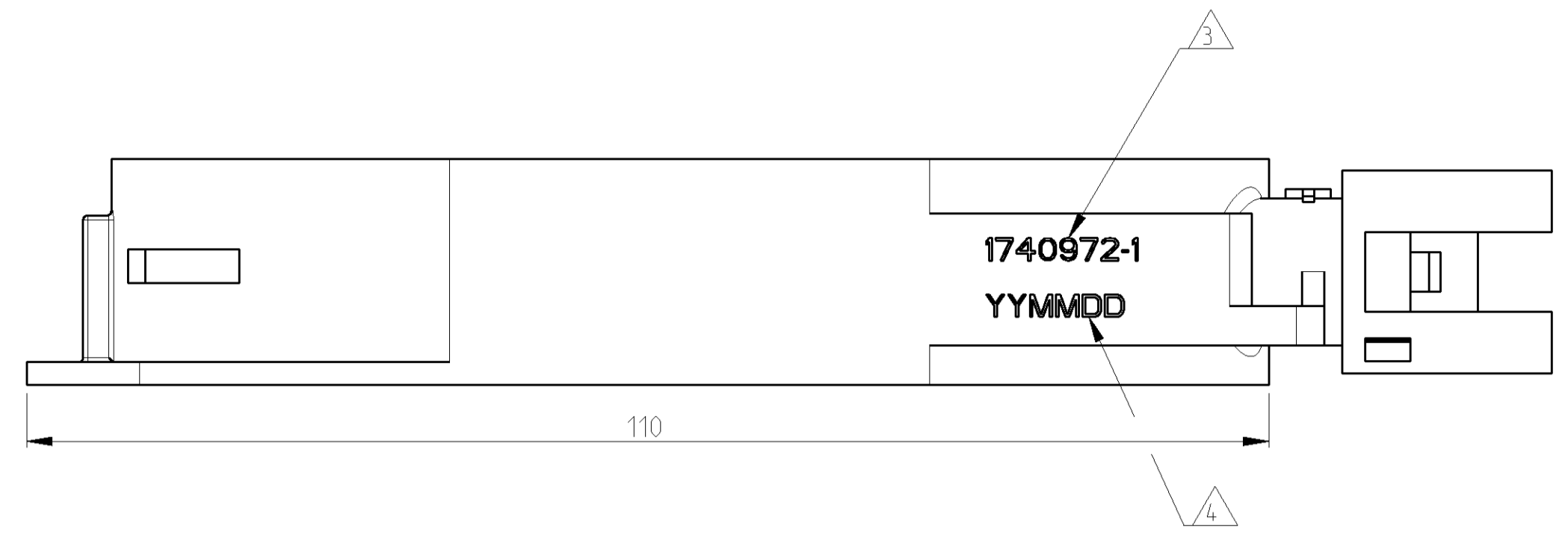

VIEW WITH ASSEMBLED COVER  
ANSICHT MIT MONTIERTEM DECKEL

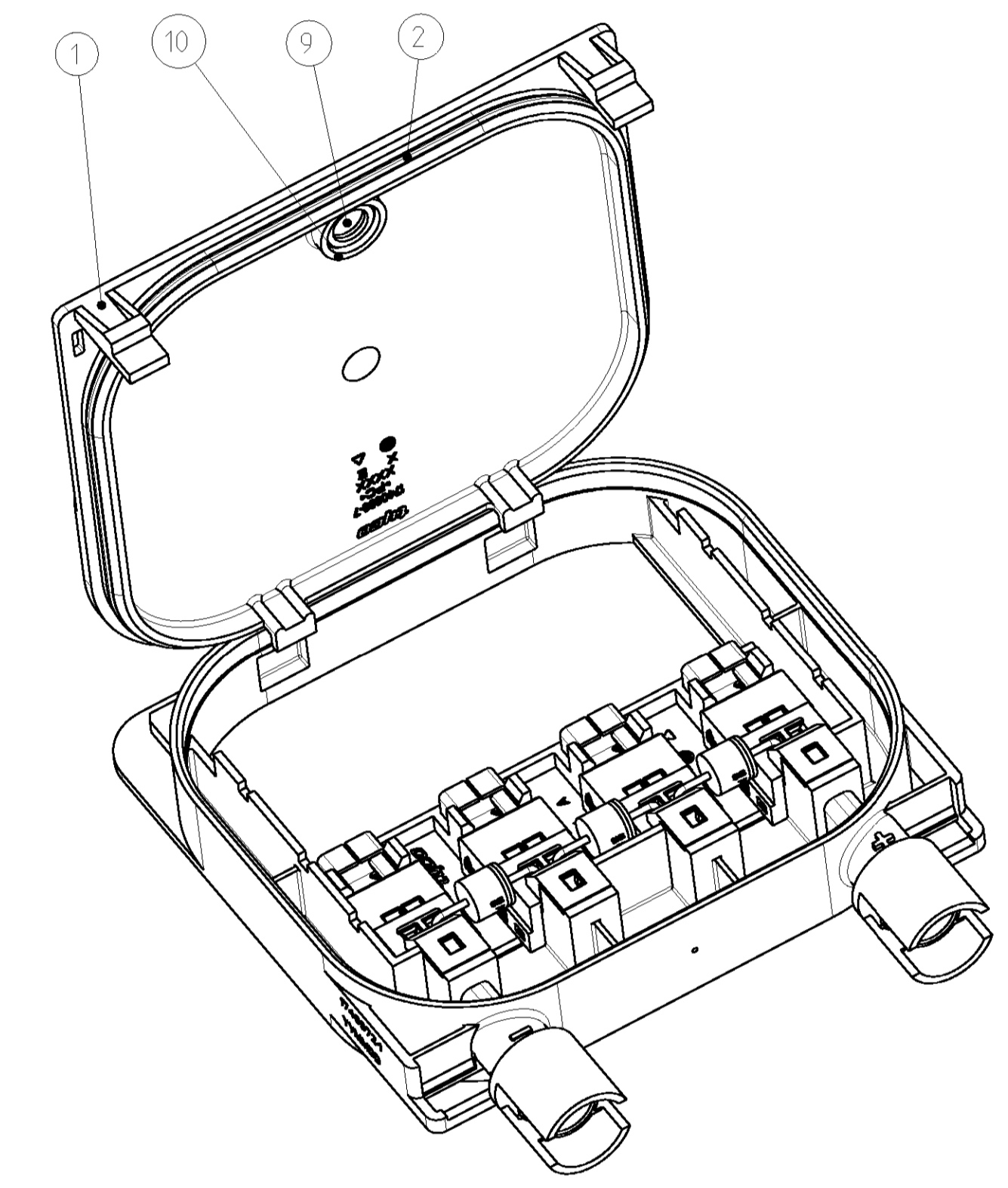

-1 AS SHOWN  
-1 WIE GEZEICHNET

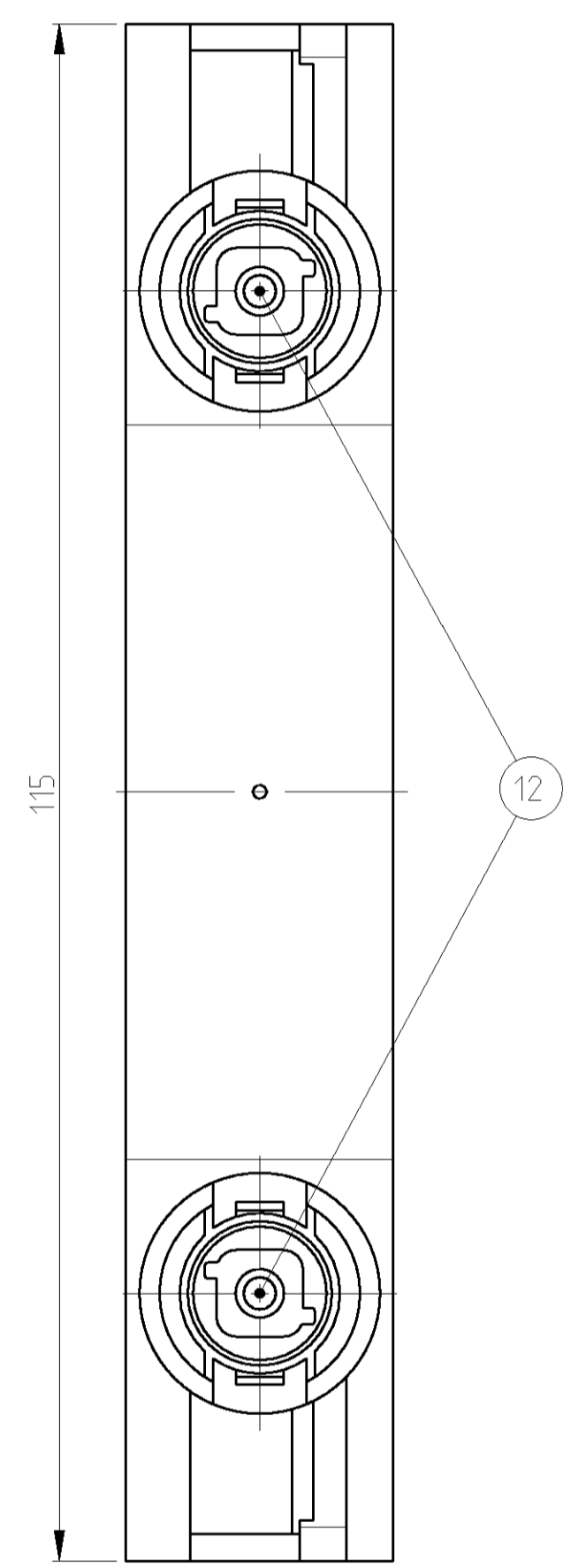
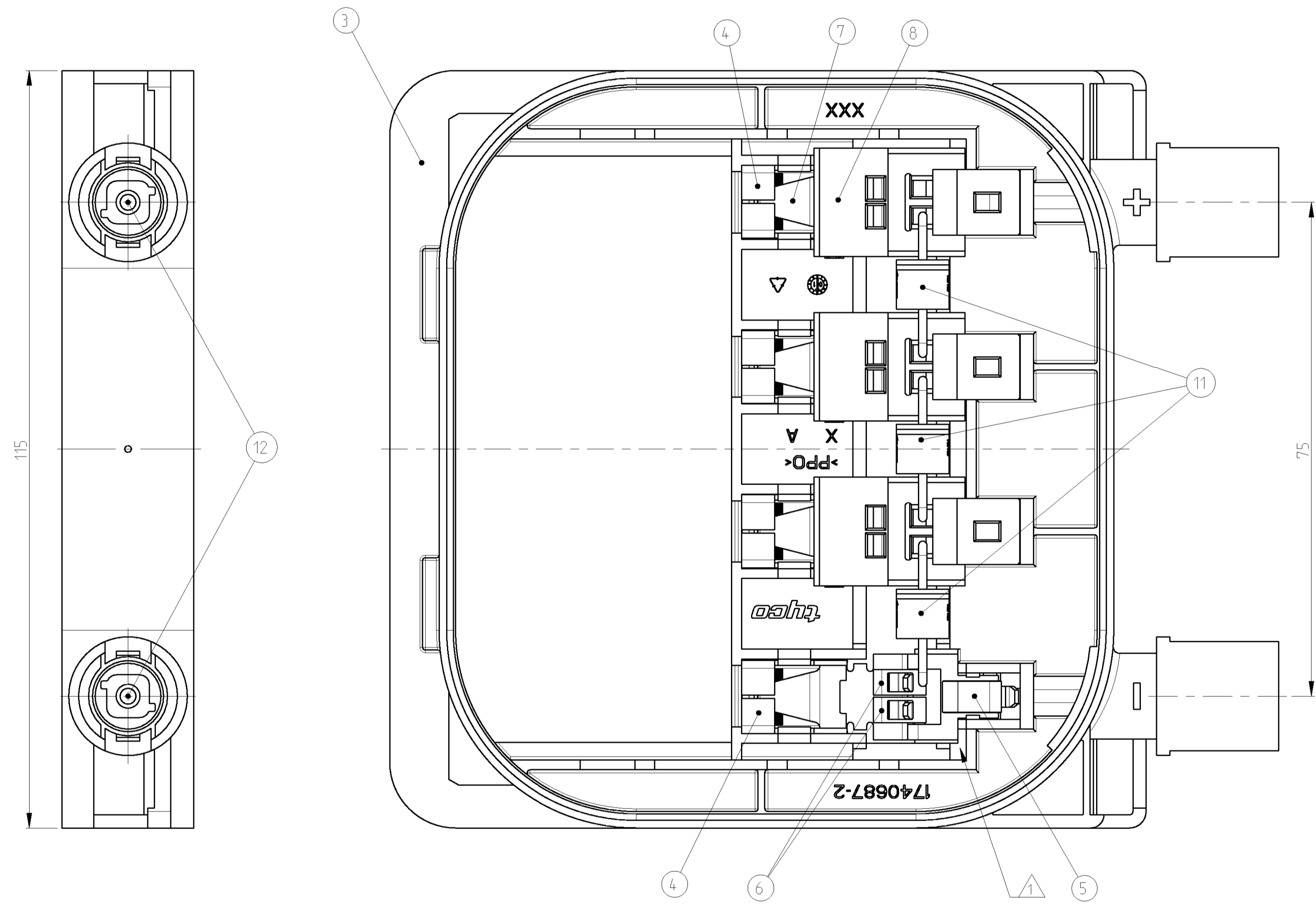

- △ SHROUDING COVER ITEM NO. 8 NOT SHOWN
- △ COVER NOT ASSEMBLED WITH LOWER PART. ENCLOSE LOOSELY
- △ PART NUMBER WITH PREFIX AND SUFFIX NUMBER
- △ PRODUCTION DATE (YYMMDD)
- 5 TOTAL HEIGHT WITH CLOSED COVER 22.5 ±0.5
- △ ABDECKHAUBE ITEM NO. 8 NICHT DARGESTELLT
- △ DECKEL NICHT MIT UNTERTEIL MONTIERT. LOSE BEIGELEGT
- △ TEILENUMMER MIT VOR- UND NACHSTRICHZAHL
- △ FERTIGUNGSDATUM (YYMMDD)
- 5 GESAMTHÖHE MIT GESCHLOSSENEM DECKEL 22.5 ±0.5

1740972-1		PART-NO. BESTELL-NR.			
-	2	12	CONTACT PIN KONTAKTSTIFT	Ag	CuZn
-	2	11	BYPASS DIODE TYPE: SL1515, PN 4-1740346-2 BYPASS DIODE TYP. SL1515 - PN 4-1740346-2	-	-
-	1	10	RING FOR ULTRASONIC WELDING RING FÜR ULTRASCHALLSCHWEISSEN	-	-
-	1	9	MEMBRANE VENTS MEMBRANE	-	-
-	4	8	SHROUDING COVER ABDECKHAUBE	BLACK SCHWARZ	PEI
-	4	7	FOIL SPRING FOLLENFEDER	PLAIN BLANK	STAINLESS STEEL ROSTFREIER STAHL
-	8	6	AMP SPRING CLAMP WITH ANTI OVERSTRESS AMP-KÄFIGZUFEDER MIT OBERDEHNFEDER	PLAIN BLANK	STAINLESS STEEL ROSTFREIER STAHL
-	2	5	AMP SPRING CLAMP WITH ANTI OVERSTRESS AMP-KÄFIGZUFEDER MIT OBERDEHNSCHUTZ	PLAIN BLANK	STAINLESS STEEL ROSTFREIER STAHL
-	4	4	CONTACT RAIL STROMSCHIENE	TIN HOT DIPPED FEUERVERZINNT	CuSn
-	1	3	SOLAR MODUL BOX LOWER PART SOLAR MODUL BÖX UNTERTEIL	BLACK SCHWARZ	PPD
-	1	2	O-RING SEAL O-RING DICHTUNG	-	-
-	1	1	SOLAR MODULE BOX COVER SOLAR MODUL BÖX DECKEL	BLACK SCHWARZ	PC
PIECES STÜCK	ITER-NO. POS.	DESCRIPTION BENENNUNG		SURFACE OBERFLÄCHE	MATERIAL
				COLOUR/FARBE	

DATE	02MAR2007	DRAWN	J.Zopf	BY	J.Zopf
REV	-	CHK	-	APPD	-
DIMENSIONS MASSENEHMEN (mm)		TOLERANCES UNLESS OTHERWISE SPECIFIED: ALL DIMENSIONS		NAME	
0 PLC	±0.1	OTHERWISE SPECIFIED:		PRODUCT SPEC.	
1 PLC	±0.1	0.15		PRODUCTSPEZ.	
2 PLC	±0.1	0.2		APPLICATION SPEC.	
3 PLC	±0.1	0.3		VERARBEITUNGSSPEZ.	
4 PLC	±0.1	0.4		MATERIAL	
MATERIAL		FINISH/SCHUBERT/FARBE		WEIGHT GEWICHT	
				CUSTOMER DRAWING	

		tyco Electronics AMP GmbH 64625 Bensheim (Germany)	
SOLARLOK R P-P 4/4 SOLARLOK R P-P 4/4		SIZE: A1 CAGE CODE: 00779 DRAWING NO.: 1740972-1	RESTRICTED TO MR. PIER
SCALE: 1:1 SHEET: 1 OF 2		REV: C1	

LOC	DIST	REVISIONS			
P	LTR	DESCRIPTION	DATE	BY	APPD
-	-	SEE SHEET 1	-	-	-

VIEW WITH ASSEMBLED COVER  
 ANSICHT MIT MONTIERTEM DECKEL

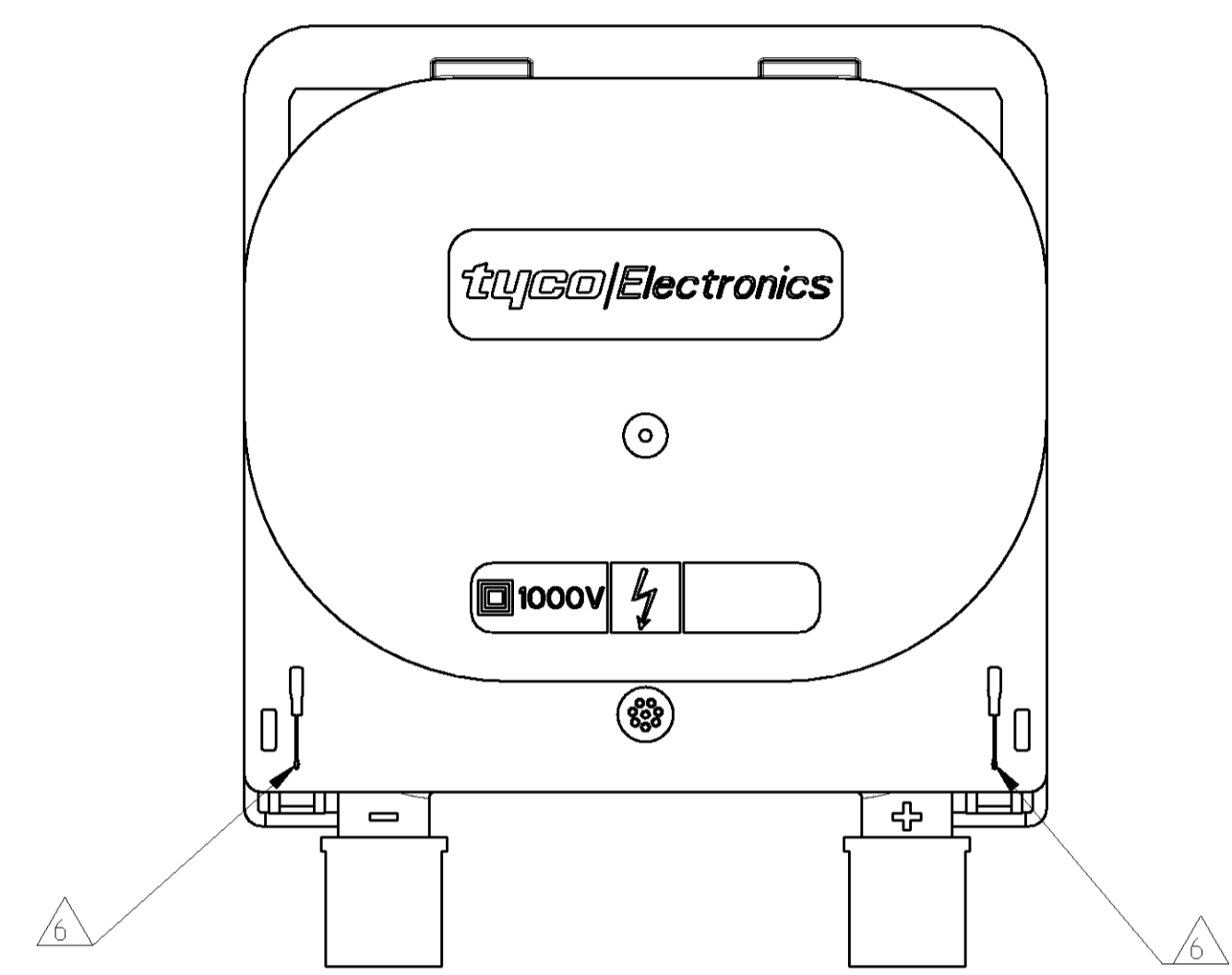

MOUNTING INSTRUCTION

- FOR COVER, ASSY:
1. MOUNT COVER ITEM NO. 1 AND 2 INTO THE LOWER PART ITEM NO. 3 AND CLOSE IT. ( LATCH SNAP IN ).
  2. RE-OPEN: PUT IN MARKED OPENING  SCREWDRIVER 3mm AND MOVE LATCH UNTIL LOCKING LATCH FREE THE COVER.

MONTAGEANWEISUNG

- FÜR DECKEL, ASSY:
1. DECKEL ITEM NO. 1 UND 2 IN DAS UNTERTEIL ITEM NO. 3 EINHÄNGEN UND SCHLIESSEN. ( LASCHE RASTET EIN ).
  2. ÖFFNEN: SCHRAUBENDREHER 3mm IN MARKIERTE ÖFFNUNG  EINSTECKEN UND LASCHE BEWEGEN BIS RASTHAKEN DEN DECKEL FREI GIBT.

PACKAGING: 60 PIECES SOLAR MODULE BOX ASSY'S PACKAGED IN CORRUGATED SHIPPING BOX PN 973056-1 PER AMP-SPEC. 107-18052.  
 5 LAYERS OF 12 PIECES.  
 USED CORRUGATED LAYER PAD PN 973163-1 FOR INTERLAYER.  
 FIFTH LAYER SOLAR MODULE BOX ASSY'S COVERED WITH CORRUGATED LAYER PAD PN 973163-1 .  
 60 PIECES SOLAR MODULE BOX COVER ASSY'S ITEM NO. 1, 3 x 5 PILES WITH 4 VICE VERSA ON TOP OF EACH OTHER STACKED LIDS IN PLASTIC BAG PN 725611-2 PUT ON THE FIFTH LAYER  
 SOLAR MODULE BOX COVER ASSY ITEM NO.1 COVERED WITH PAPER CUSHION PN 740045-1

PACKAGING UNIT: 60 PIECES  
MINIMUM ORDER QUANTITY: 60 PIECES

VERPACKUNG: 60 STÜCK SOLAR MODUL BOX ASSY'S VERPACKT IN VERSANDKARTON PN 973056-1 NACH AMP-SPEZ. 107-18052.  
 5 LAGEN ZU JE 12 STÜCK.  
 ZWISCHENLAGENWELLPAPIER PN 973163-1 ALS ZWISCHENLAGE VERWENDET.  
 FÜNFTE LAGE SOLAR MODUL BOX ASSY'S MIT ZWISCHENLAGENWELLPAPIER PN 973163-1 ABGEDECKT.  
 60 STÜCK SOLAR MODUL BOX DECKEL ASSY'S ITEM NO. 1, 3 x 5 STAPEL MIT 4 UMGEKEHRT ÜBEREINANDERGESTAPELTEN DECKELN IN KUNSTSTOFF-BEUTEL PN 725611-2 VERPACKT AUF DIE FÜNFTE LAGE  
 SOLAR MODUL BOX DECKEL ASSY'S ITEM NO.1 MIT PAPIERPOLSTERKISSEN PN 740045-1 ABGEDECKT

VERPACKUNGSEINHEIT: 60 STÜCK  
MINDESTBESTELLMENGE: 60 STÜCK

-1 AS SHOWN  
 -1 WIE GEZEICHNET

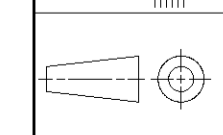
<small>THIS DRAWING IS UNPUBLISHED. RELEASED FOR PUBLICATION 2006. IT IS THE PROPERTY OF TYCO ELECTRONICS CORPORATION. IT IS TO BE USED ONLY FOR THE PURPOSES AND ORGANIZATION SPECIFIED HEREIN. CONTACT TYCO ELECTRONICS CORPORATION FOR ALL OTHER INFORMATION.</small>		DWN: J.Zapf 02MAR2007 CHK: - APVD: -	<b>tyco Electronics</b> Tyco Electronics AMP GmbH 64625 Bensheim (Germany)
DIMENSIONS: mm 	TOLERANCES UNLESS OTHERWISE SPECIFIED: 0 PLC ± 1 PLC ± 2 PLC ± 3 PLC ± 4 PLC ± ANGLES ±1° FINISH -	PRODUCT SPEC - APPLICATION SPEC - WEIGHT - CUSTOMER DRAWING -	NAME: SOLARLOK R P-P 4/4 SOLARLOK R P-P 4/4 SIZE: A   00779   C=1740972-1 SCALE: 1:1 SHEET 2 OF 2 REV C 1